

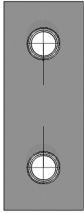

Diagrams of Standard Transfer Panel Configurations*

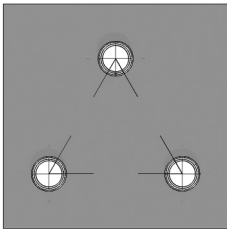

2 Line



3 Triangle

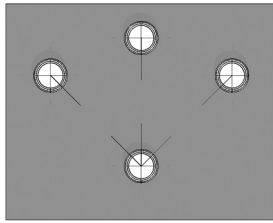

3 Around 1

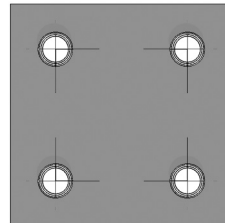

4 Square

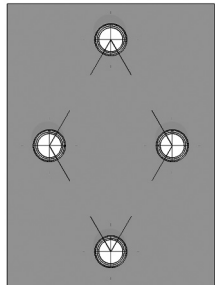

4 Diamond

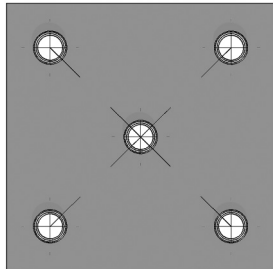

4 Around 1

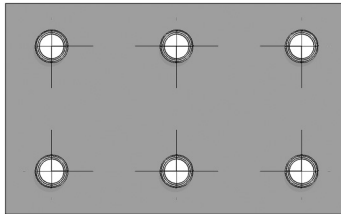

6 Rectangle

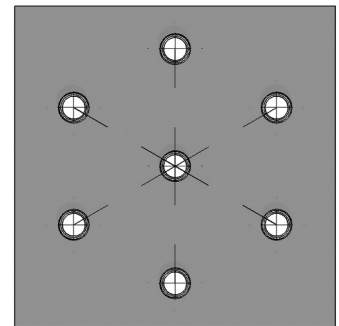

6 Around 1

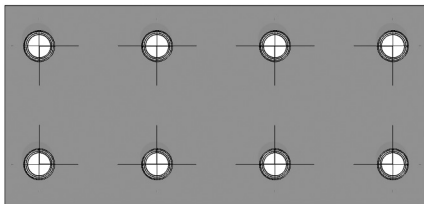

8 Double Square

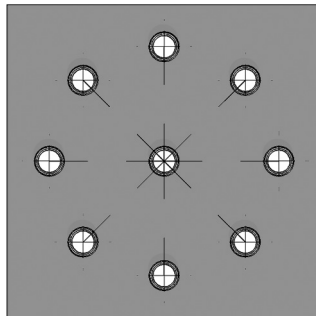

8 Around 1

*Custom transfer panels and non-standard sizes available

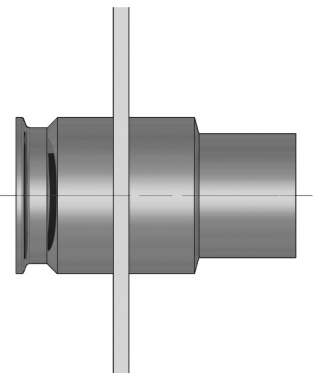

Our AL-6XN alloy spool design (US Patented) allows installation of product contact AL-6XN alloy spools into 304 stainless steel panels while maintaining the integrity of the corrosion resistant elements of the AL-6XN alloy as required by ASME-BPE-2002 specifications.

